

WE Walker[®]
Edison
furniture company

Item # : OMT42
Assembly Instructions



Please visit our website for the most current instructions, assembly tips, report damage, or request parts. www.walkeredison.com

Revised 03/2017

Parts List

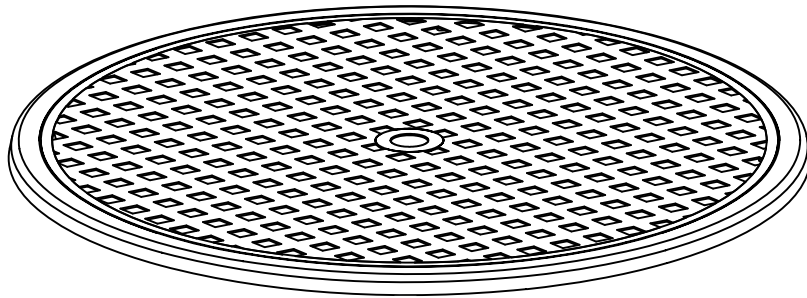

1

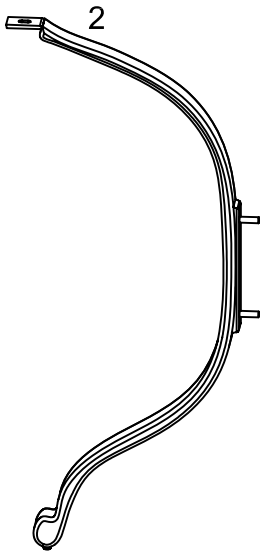

2

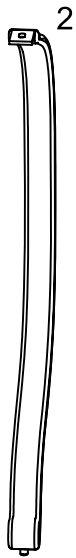

2

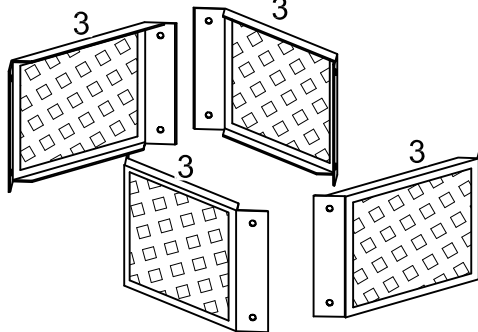

3

3

3

3





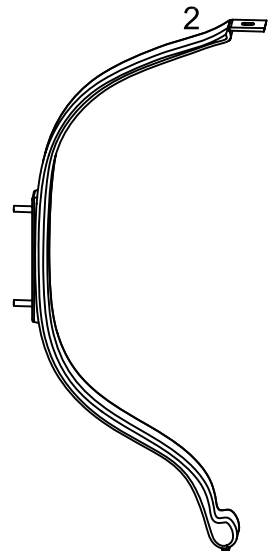

2



2

Hardware List

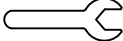
A		Ø6*35	Bolt	4 pcs
B		Ø1/4"	Washer	12 pcs
C		Ø1/4"	Spring washer	12 pcs
D			Nut	12 pcs
E			Nut cap	12 pcs
F			Wrench	1 pc

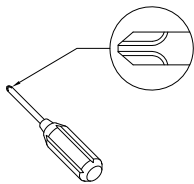

Philips head screwdriver required for assembly
(not included)

*The hardware quantities listed above are required for proper assembly.
Some extra hardware may also have been included.*

Step 1

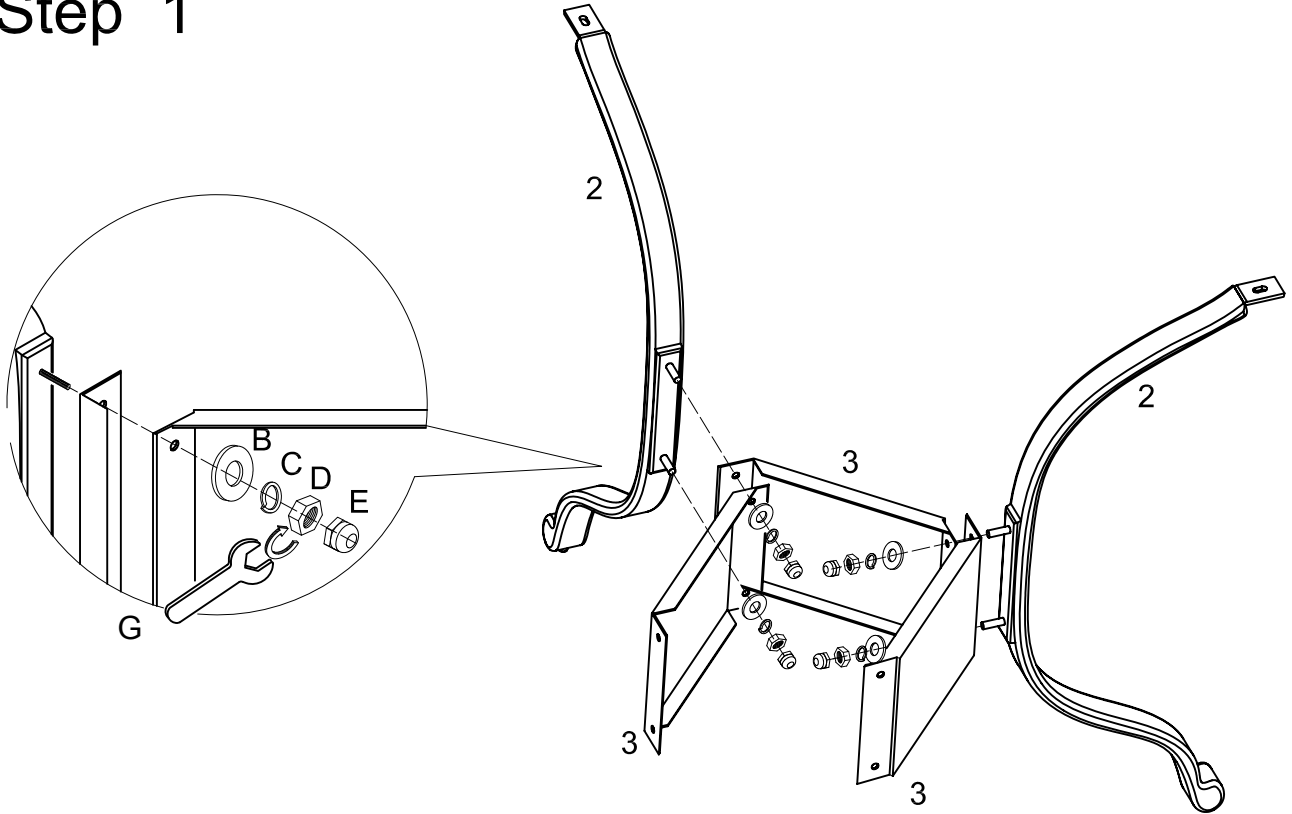

Use wrench (G), nut (D), spring washer (C), and washer (B) to secure the support frame (3) to the leg (2), and cover with nut cap (E) to the nut (D).

Step 2

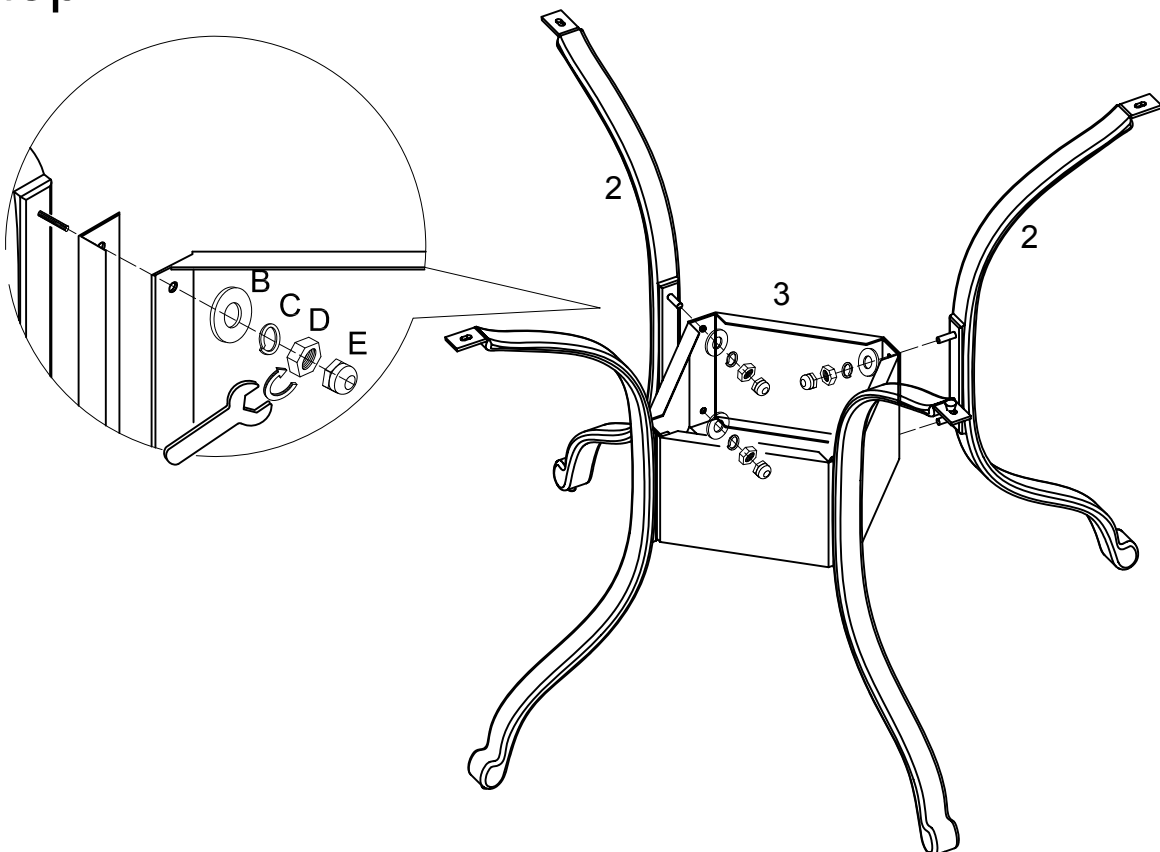

Use wrench (G), nut (D), spring washer (C), and washer (B) to secure the support frame (3) to the leg (2), and cover with nut cap (E) to the nut (D).

Step 3

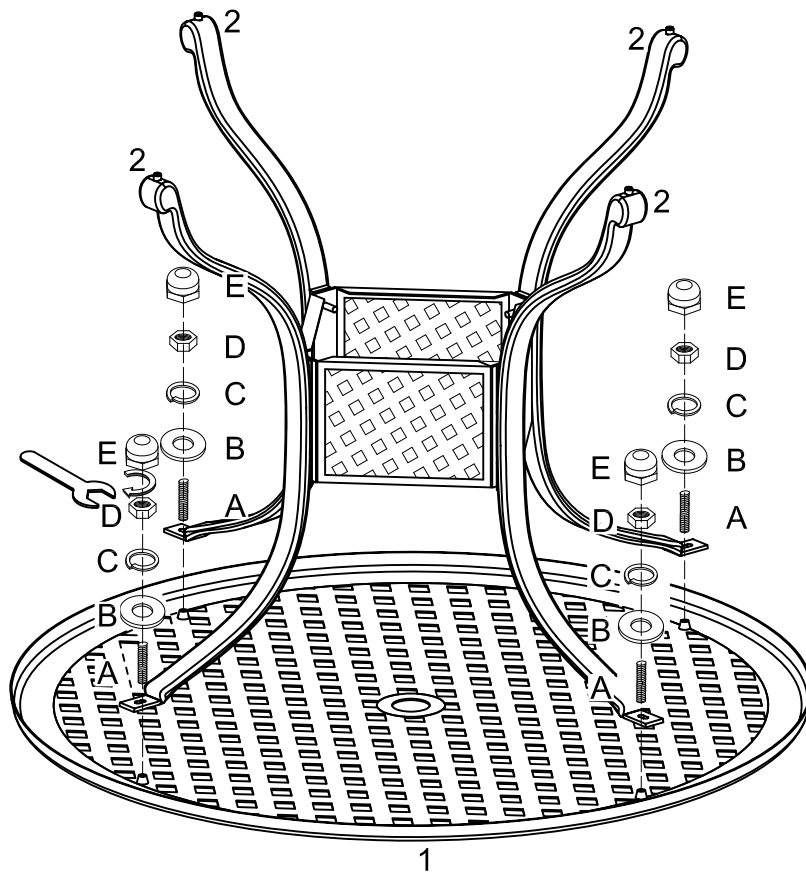

Use wrench (G), nut (D), spring washer (C), and washer (B) to secure the leg (2) to the table top frame (1), and cover with nut cap (E) to the nut (D).

Step 4



Final Assembly